



MODEL NO.: 53355

3.5-Ton Floor Jack — Heavy Duty *Owner's Manual*



WARNING:

IMPORTANT: READ THESE INSTRUCTIONS AND ALL WARNINGS PRIOR TO USING THIS EQUIPMENT. UNDERSTAND ALL OPERATING PROCEDURES, SAFETY WARNINGS AND MAINTENANCE REQUIREMENTS. FAILURE TO DO SO COULD CAUSE AN ACCIDENT RESULTING IN SERIOUS OR FATAL INJURY AND/OR PERSONAL PROPERTY DAMAGE.

A



Brand

surewerx.com

Viking 53355-INST-3.24.23-FA



GENERAL DESCRIPTION

PRODUCT DESCRIPTION

The hydraulic trolley jack is designed to lift, but not support, one end of a vehicle. Immediately after lifting, loads must be supported by a pair of appropriately rated jack stands.

Capacity	3.5 TON
Minimum Height	3.75"
Maximum Height	20.5"
Length	29.75"
Weight	88.1 lbs

SAFETY INFORMATION

Important: Read these instructions carefully. **NOTE THE SAFE OPERATIONAL REQUIREMENTS, WARNINGS, AND CAUTIONS. USE THIS JACK CORRECTLY AND WITH CARE FOR THE PURPOSE FOR WHICH IT IS INTENDED.** Failure to do so may cause damage or personal injury and will invalidate the warranty. Retain THESE INSTRUCTIONS for future use.

To avoid personal injury or property damage during operation, read and follow all **CAUTIONS, WARNINGS, and INSTRUCTIONS** included with, or attached to, each product.

▲ WARNING

- 2.1 Locate the jack in a suitable working area.
- 2.2 Inspect the jack before each use. Do not use jack if damaged, altered, modified, in poor condition, leaking hydraulic fluid, or unstable due to loose or missing hardware or parts. Make corrections before using.
- 2.3 Use jack on level and solid ground, preferably concrete. Avoid tar macadam as jack may sink in. Chock wheels of vehicle.
- 2.4 Ensure the vehicle handbrake is engaged, engine is switched off, and transmission is in gear (or "PARK" if automatic).
- 2.5 Ensure minimum distance of 0.5 m between vehicle and static objects such as doors, walls, etc., to allow for vehicle tilting.
- 2.6 Ensure all non-essential persons keep a safe distance while the jack is in use.
- 2.7 Do not exceed the rated capacity of the jack.
- 2.8 Place jack under only those lifting points recommended by vehicle manufacturer (see vehicle handbook)
- 2.9 Check that the lifting point is stable and centered on the jack saddle.
- 2.10 Ensure the jack wheels are free to move and that there are no obstructions.
DANGER: Use the jack for lifting only
- 2.11 Ensure there are no persons or obstructions beneath the vehicle before lowering.
- 2.12 Use suitable axle stands under the vehicle before proceeding with any task.
- 2.13 Use a qualified person to lubricate and maintain the jack.
- 2.14 Wear ANSI-approved safety goggles and heavy-duty working gloves during use.
- 2.15 Ensure that only hydraulic jack oil is used in the jack.
DO NOT operate the jack if damaged.
DO NOT allow untrained persons to operate the jack.
DO NOT exceed the rated capacity of the jack.
DO NOT allow the vehicle to move during lifting or lowering or use the jack to move the vehicle.
DO NOT jack the vehicle if there is a risk of spillage of fuel, battery acid, or other dangerous substances.
DO NOT work under the vehicle until appropriately supported.
DO NOT fill hydraulic system with brake fluid, alcohol, or transmission oil. Use hydraulic jack oil only.
DO NOT adjust the safety overload valve.
DO NOT use for aircraft purposes.
- 2.16 When not in use, store the jack, fully lowered, in a safe, dry, childproof location.

The warnings, precautions, and instructions discussed in this manual cannot cover all possible conditions and situations that may occur. The operator must understand that common sense and caution are factors which cannot be built into this product, but must be supplied by the operator.



ASSEMBLY

3.1 IMPORTANT RECEIVING INSTRUCTIONS

Visually inspect all components for shipping damage. If any shipping damage is found, notify the carrier at once. Shipping damage is NOT covered by warranty. The carrier is responsible for all repair or replacement costs resulting from damage in shipment.

3.1.1 CHECK THE PARTS IN THE CARTON

Visually inspect all components for any missing parts or damage. Refer to the packing list below.

PACKING LIST

No.	Description	Qty
1	Handle tube 1	1
2	Handle tube 2	1
3	Jack body	1
4	Instruction manual	1

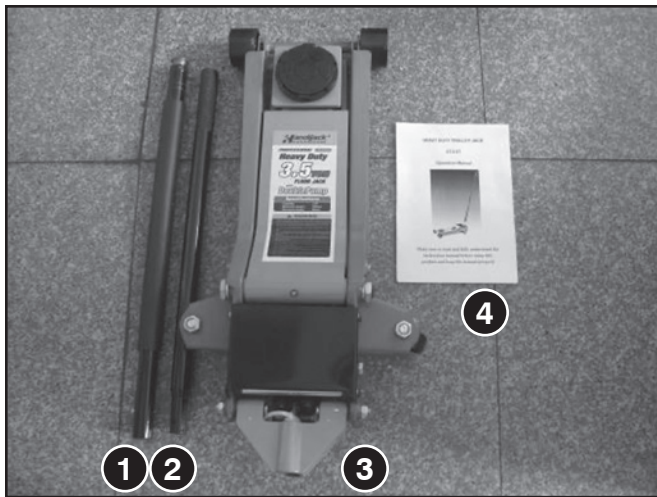

3.2 ASSEMBLY

3.2.1 The jack comprises the following parts:
jack body, two-part pumping handle.

3.2.2 Take out the two-part pumping handle and
insert the upper handle into the lower handle.



3.2.3 The handle socket is pressed down and supported by a nylon supporting block in the package during transportation. Before assembling, please take out the nylon supporting block.

3.2.4 Undo the screw (B) in the handle socket, until it no longer protrudes into the handle socket.

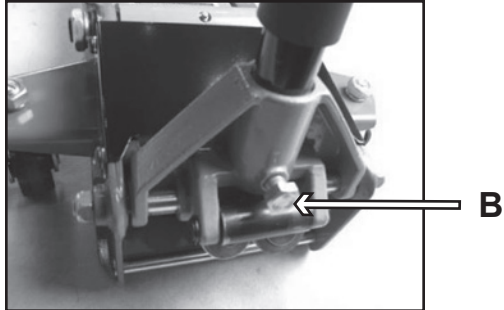

3.2.5 Insert the pump handle into the handle socket hole completely.

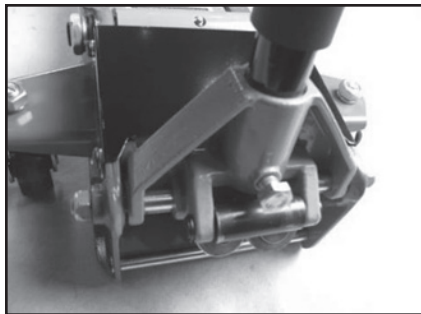

3.2.6 Ensure that the handle is correctly inserted into the socket, then tighten the handle socket screw (B). Please make sure that the handle can be turned smoothly.

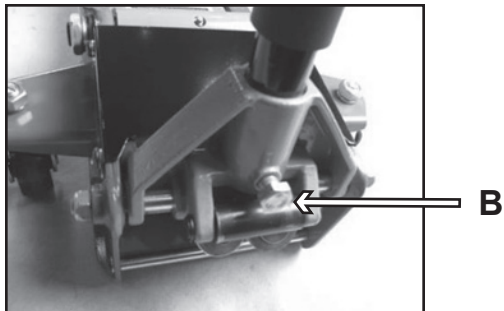



HYDRAULIC SYSTEM PURGING

- 4.1 Open the release valve by turning it two full turns counter-clockwise.
- 4.2 Pump the handle a minimum of four full strokes quickly.
- 4.3 Close the release valve by turning it clockwise.
- 4.4 Pumping the handle with full strokes to check if it can reach the maximum height by seven pumps.

If it can't reach the maximum height by seven pumps, please refer to the following special purging process:

- 4.5 Open the release valve by turning counter-clockwise and lower the lifting arm to the minimum height.
- 4.6 Put the jack on a flat working table, carefully lift and support the front part of the jack to make sure the front part is at least 500 mm higher than the end part of the jack.
- 4.7 Pump the handle a minimum of four full strokes quickly.
- 4.8 Put the jack on a flat surface and close the release valve by turning it clockwise.
- 4.9 Pumping the handle with full strokes to check if it can reach the maximum height by seven pumps; if not, please repeat the special purging process again.

OPERATING INSTRUCTIONS

⚠ WARNING

Before use, ensure you have read and understood **Section 1, Safety Instructions**.

⚠ IMPORTANT

Before use, the operator is to visually inspect the jack for cracked welds, damaged or missing parts, or hydraulic leaks.

5.1 RAISING A VEHICLE

- 5.1.1 Ensure that the jack and the vehicle are on a hard, level surface.
- 5.1.2 Always ensure that the vehicle handbrake is engaged and that the vehicle wheels are chocked.
- 5.1.3 Consult the vehicle manual to determine the location of jacking points. Position the jack under a suitable lifting point.
- 5.1.4 Turn the handle clockwise, to close the release valve. **DO NOT** over-tighten.
- 5.1.5 Raise the vehicle to the desired height by pumping the handle up and down.
- 5.1.6 **Immediately support the vehicle with appropriate means such as vehicle support stands.**
- 5.1.7 Turn the release valve slowly counter-clockwise to lower the vehicle onto the axle stands.

5.2 LOWERING A VEHICLE

- 5.2.1 Ensure that the area under and around the vehicle is clear of people and obstructions.
- 5.2.2 Turn the release valve clockwise to close it.
- 5.2.3 Pump the handle to raise the vehicle off the axle stands.
- 5.2.4 Remove the vehicle support stands from beneath the vehicle.
- 5.2.5 Turn the release valve slowly counter-clockwise to lower the vehicle to the ground.

NOTE: When the jack is not in use, ALWAYS leave the saddle and ram fully retracted.

CAUTION: Keep hands and feet away from the hinge mechanism of the jack.

IMPORTANT: Only fully qualified personnel should attempt maintenance or repair.



MAINTENANCE

6.1 MONTHLY MAINTENANCE

Periodic lubrication is critical to jacks since they support heavy loads. Any restriction due to dirt or rust can cause either slow jack movement or extremely rapid jerks, causing damage to the internal components. To keep the jack well lubricated, carry out the following steps.

6.1.1 Lubricate the linkages, the saddle, and the pump mechanism with light oil.

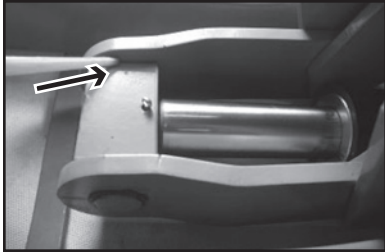

Linkage (1)

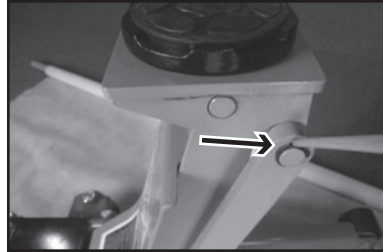

Linkage (2)

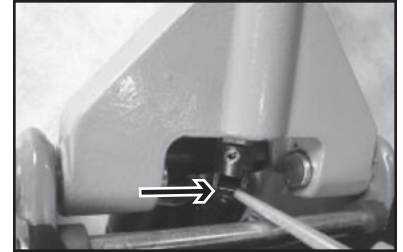

Linkage (3)

6.1.2 Grease the wheel bearing and axles.

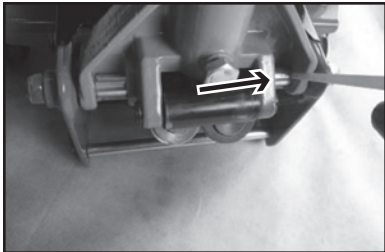

Roller Pin (right)

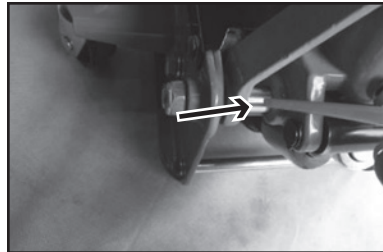

Roller Pin (left)



Lifting Arm

6.1.3 Keep all jack surfaces and warning labels clean.

6.1.4 Check and maintain the ram oil level (**Section 6.3**).

6.2 THREE-MONTH MAINTENANCE

6.2.1 At three-month intervals, check the pump for any signs of rust or corrosion. Clean the pump as required and wipe with an oilcloth.

6.3 CHECKING THE OIL LEVEL

6.3.1 Fully retract the ram by turning the release valve counterclockwise.

6.3.2 Loosen the four top plate retaining screws (no need to screw out) and remove the top plate vertically as per the following picture.

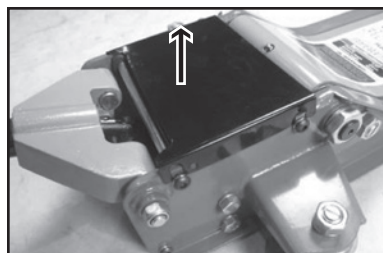
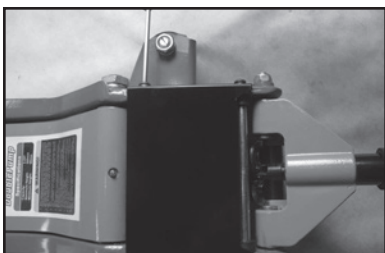

- 6.3.3 With the jack in the level position, remove the oil filler plug.
- 6.3.4 The proper oil volume should be no more than 13 mm from the top of the oil tank to the oil surface. If it is too low, please add high-quality hydraulic oil according to **Section 6.4**.
- 6.3.5 Replace the oil filler plug.
- 6.3.6 After adding oil, please check if the jack can reach the maximum height with seven pumps; if not, please purge air from the hydraulic unit as required. Refer to **Section 4**.
- 6.3.7 Cover the top plate, making sure the four grooves in the top plate line up with the four retaining screws as per the following picture. Then tighten the four screws.

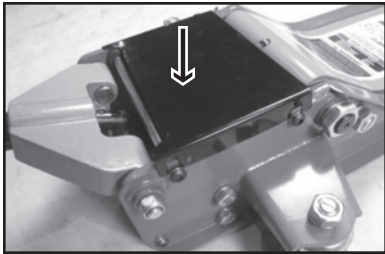

6.4 ADDING OIL

- 6.4.1 Fully retract the ram by turning the release valve counterclockwise.
- 6.4.2 Loosen the four top plate retaining screws (no need to screw out) and remove the top plate vertically as pictured below.

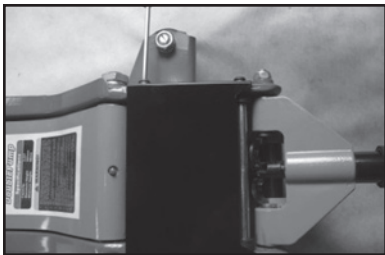

Undo the retaining screw

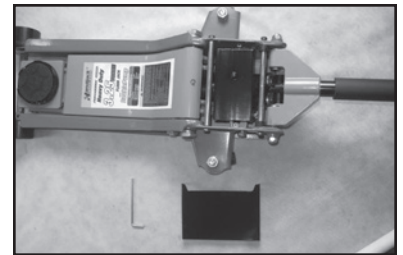
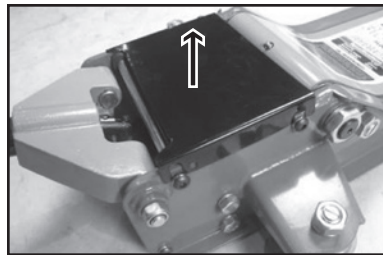

Remove the top plate

- 6.4.3 With the jack in the level position, remove the oil filler plug.

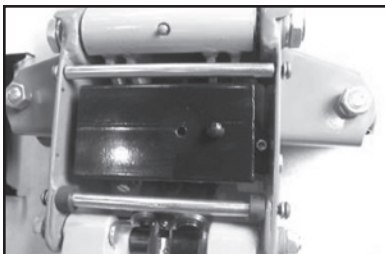

6.4.4 Fill oil to no less than 13 mm from the top of the tank to the oil surface level.

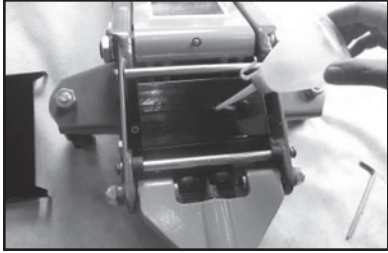

6.4.5 Replace the oil filler plug and purge air from the hydraulic unit as required. Refer to **Section 4**.

6.4.6 Replace the top plate, ensuring the four retaining screws line up as shown in the following picture, and tighten the four screws.

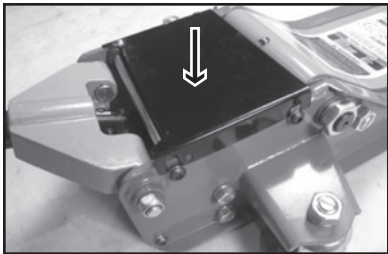

6.5 CHANGING OIL

For best performance and longest life, replace the complete fluid supply regularly.

6.5.1 Fully retract the ram by turning the release valve counterclockwise.

6.5.2 Loosen the four top plate retaining screws (no need to screw out) and remove the top plate vertically as per the following picture.

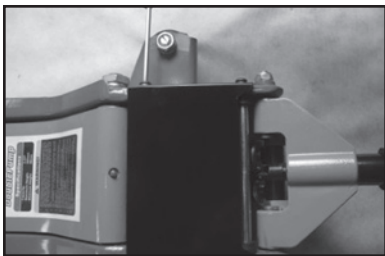

Undo the retaining screw

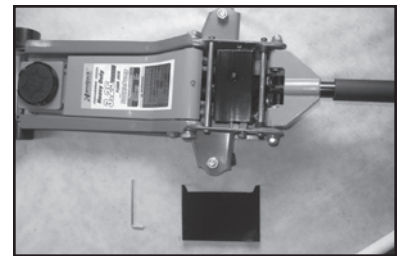
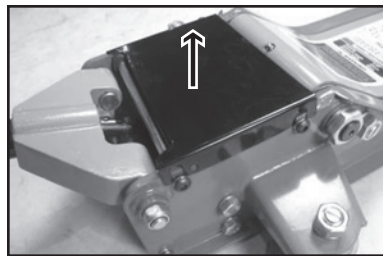

Remove the top plate

6.5.3 Unscrew the hexagon socket screw and take out the oil tank vertically by hand.

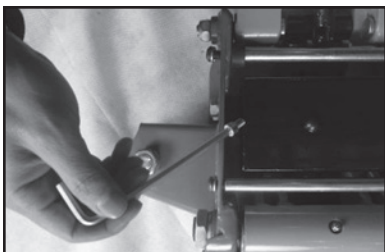

Unscrew the hexagon socket screw

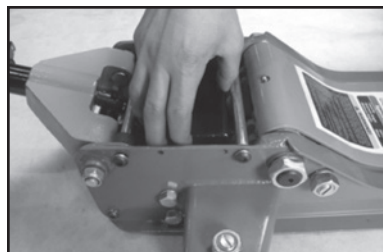

Take out the oil tank



6.5.4 Remove the oil filler plug and turn the oil tank upside down, press the oil valve (please note: never cover the hole on the oil valve when pressing it) and then empty the oil tank.



How to press the oil valve

Note: Dispose of hydraulic oil in accordance with local regulations.

6.5.5 Add 400 ml of high-quality hydraulic oil to the oil tank.

6.5.6 Replace the oil filler plug, put the oil tank back into the pump base and lock it by the hexagon screw.

6.5.7 Replace the top plate, then tighten the retaining screws.

6.5.8 After adding oil, please check if there is any air in the hydraulic system. Close the release valve clockwise, pumping the handle with a full stroke. If the jack can't reach the maximum height with seven pumps, refer to the purging process in **Section 4**.

NOTE: Always store the jack in the fully lowered position. This will protect critical areas from excessive corrosion.

IMPORTANT: NO RESPONSIBILITY IS ACCEPTED FOR THE INCORRECT USE OF THIS PRODUCT.

De-commissioning the Jack

Should the jack become completely unserviceable and require disposal, draw off the oil into an approved container and dispose of the jack and oil in accordance with local regulations

TROUBLESHOOTING

PROBLEM	CAUSE	REMEDY
Jack will not lift to full height	1. Oil level low 2. Release valve not closing	1. Check / add oil 2. Close the release valve
Jack will not hold the load	1. Release valve not closing 2. Hydraulic oil is contaminated 3. Pump leaking	1. Close the release valve 2. Contact authorized service agent
Lift arm will not lower	1. Pump cylinder binding 2. Parts worn 3. Internal component damage 4. Return spring broken or unhooked 5. Lift arm linkage either bent or binding 6. Air in the hydraulic system	1. Contact authorized service agent
After hydraulic purging, the jack still can't reach the maximum by seven pumps	1. Still have air in the hydraulic system	1. Purge air according to manual Part 4.5
Poor lift performance	1. Fluid level low 2. Hydraulic unit malfunction	1. Ensure proper fluid level 2. Discontinue use, contact authorized service agent

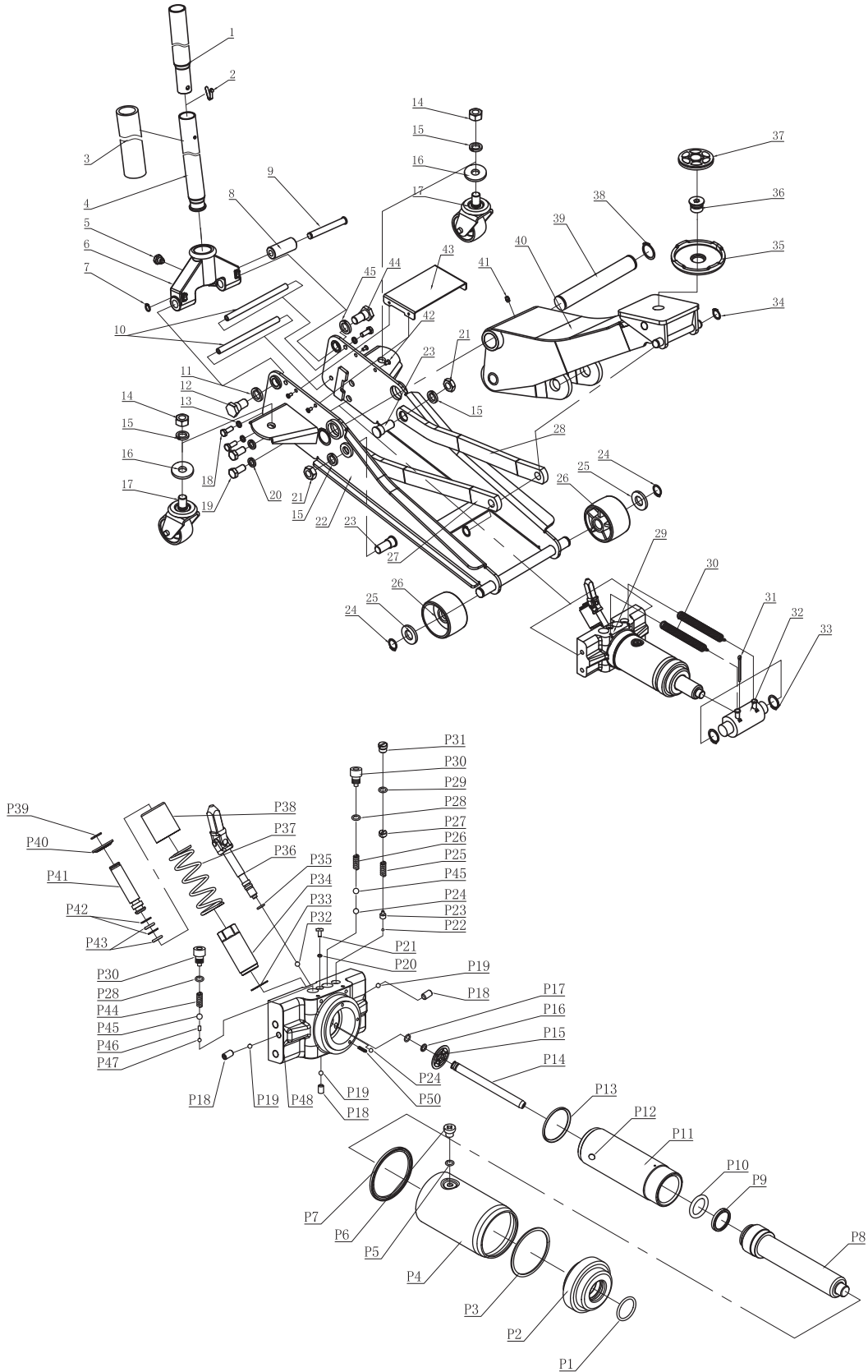



**PARTS LIST: 3.5-TON FLOOR JACK — HEAVY DUTY — PARTS BREAKDOWN —
Prod. No. 53355**

PART NUMBER	KIT DESCRIPTION	REF. #	KIT INCLUDES
53355-1	Upper Handle	1	Upper Handle
	Lower Handle	4	Lower Handle
53355-2	Location Pin	2	Location Pin
53355-3	Handle Protection	3	Handle Protection
53355-5	Handle Bolt	5	Handle Bolt
53355-43	Cover	43	Cover
	Screws Qty 4	42	Screws Qty 4
53355-17	Caster	17	Caster
	Washer	16	Washer
	Lock Washer	15	Lock Washer
	Nut	14	Nut
53355-26	Wheel	26	Wheel
	Washer	25	Washer
	Retaining Ring	24	Retaining Ring
53355-29	Hydraulic Unit	29	Hydraulic Unit
53355-30	Springs	30	Springs
53355-32	Push Rod	32	Push Rod
	Retainer Ring	33	Retainer Ring
53355-P36	Release Valve	P36	Release Valve
53355-RK	Repair Kit		Repair Kit
53355-35	Saddle	35	Saddle
	Bolt	36	Bolt
	Saddle Pad	37	Saddle Pad



LIMITED WARRANTY

SureWerx USA WARRANTS TO ITS CUSTOMERS THAT THE COMPANY'S SureWerx USA "AFF" BRANDED PRODUCTS ARE FREE FROM DEFECTS IN WORKMANSHIP AND MATERIALS.

SureWerx USA will repair or replace its **SureWerx USA "AFF"** branded products which fail to give satisfactory service due to defective workmanship or materials, based upon the terms and conditions of the following described warranty plans attributed to that specific product. This product carries a ONE-YEAR warranty. During this warranty period, **SureWerx USA** will repair or replace at our option any part or unit which proves to be defective in material or workmanship.

Other important warranty information:

This warranty does not cover damage to equipment or tools arising from alteration, abuse, misuse, damage and does not cover any repairs or replacement made by anyone other than **SureWerx USA**. The foregoing obligation is **SureWerx USA's** sole liability under this or any implied warranty and under no circumstances shall we be liable for any incidental or consequential damages.

Note: Some states do not allow the exclusion or limitation of incidental or consequential damages, so the above limitation or exclusion may not apply to you. If you have any questions about warranty service, please contact **SureWerx USA**. This warranty gives you specific legal rights and you may also have other rights which vary from state to state.

A



surewerx.com

Brand

SureWerx, USA Inc.,
325 Corporate Drive, Elgin, IL USA 60123
surewerx.com/usa
affjaxx.com
800-323-7402

53355-INST-0323